

IDEA+
PANNELLO

design office



TOPS

30 mm melamine faced chipboard (MFC) finished with 2 mm matching straight ABS impact resistant edges, easy to clean scratch-resistant anti-reflective melamine. MFC density 670/730 kgs per cubic meter.

Finish options:



PANEL END LEGS



Panel legs made of 25mm melamine faced chipboard (MFC) with 2mm matching impact resistant Abs straight edges. 18mm Mfc structural modesty panel with matching melamine straight edges. Easy to clean scratch-resistant anti-reflective melamine

PANNELLO

Finish options:



PANEL DESK

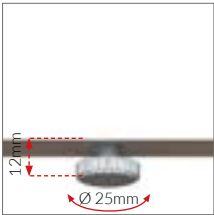
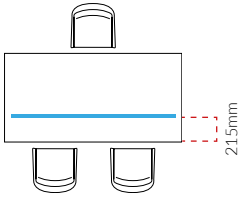
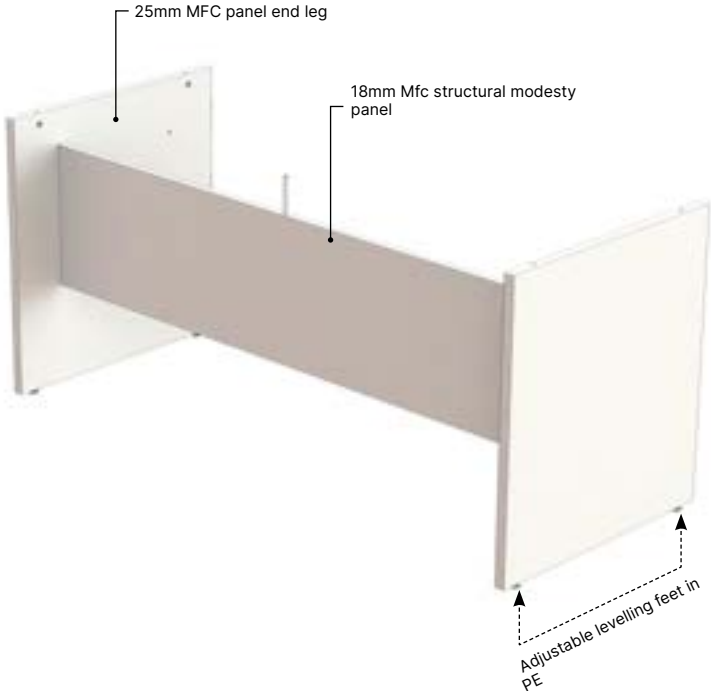

0-12mm adjustable levelling feet made of polyethylene, 25mm diameter.

SINGLE DESKS

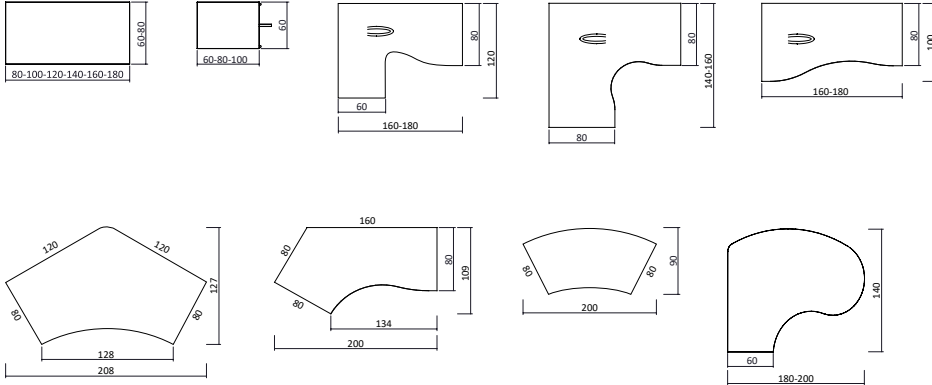

DESKS WITH DESK HIGH CABINET/PEDESTAL

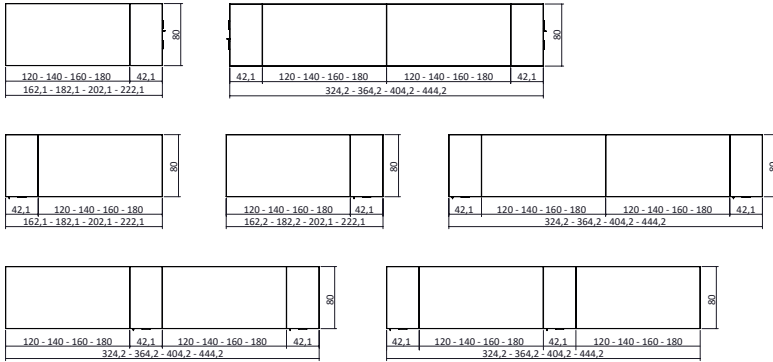

LINKING AND EXTENSION UNITS FOR DESKS AND BENCH DESKS

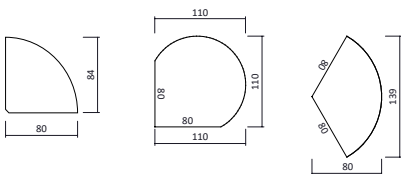

SINGLE DESKS

SINGLE DESK

- 1) 30mm desktop
- 2) Static beam for O1/Tube frames
- 3) Structural modesty panel for Panel frames
- 4) Tube frame
- 5) O1 frame
- 6) Panel end legs

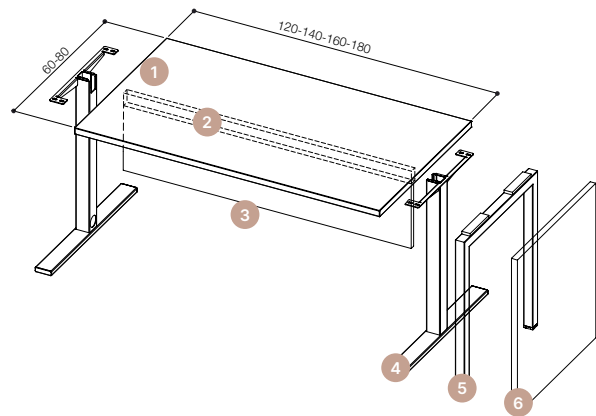

SINGLE DESK SUPPORTED ON DESK HIGH CABINET/PEDESTAL

- 1) Panel end legs
- 2) O1 frame
- 3) Tube frame
- 4) 30mm desktop
- 5) Static beam for O1/Tube frames
- 6) Structural modesty panel for Panel legs
- 7) Linking brackets for desk high cabinets/pedestals
- 8) Desk high cabinet/pedestal

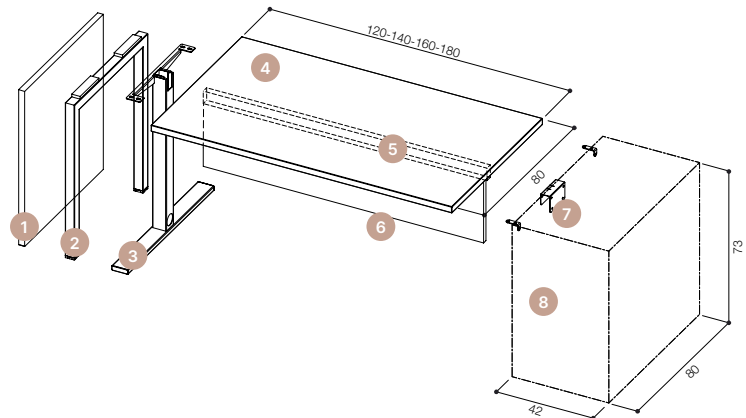

SINGLE DESK SUPPORTED ON LOW CREDENZA UNIT

- 1) O1 frame
- 2) Tube frame
- 3) 30mm desktop
- 4) Static beam for O1/Tube frames
- 5) Tube leg for desks supported on low credenza units
- 6) O1 leg for desks supported on low credenza units
- 7) Metal beams to prevent bending
- 8) Low credenza unit

FRAMELESS SCREENS SUPPORTED ON DESK RAIL, CABLE MANAGEMENT

- 1) Melamine frameless screen / fabric covered frameless screen / etched glass frameless screen - includes two U-shaped mounting brackets for fitting to desk rails
- 2) Acoustic frameless screen made of fabric covered thermoformed polyester fibre - includes two mounting brackets for fitting to desk rails

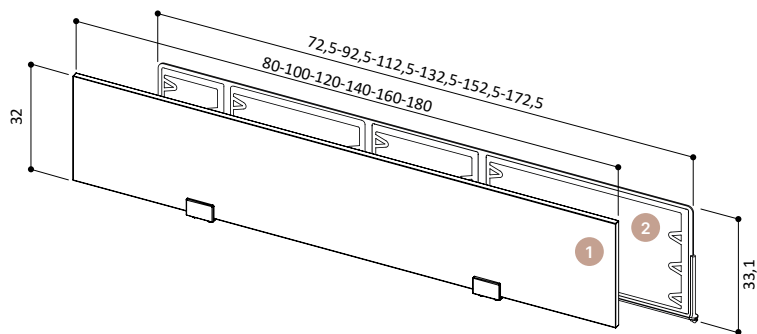

OPTIONS FOR SINGLE & BENCH DESKS (A FRAMELESS SCREEN MAY BE OPTIONALLY FITTED TO THE RAIL)

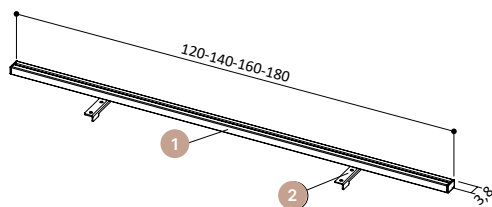

Metal rail for single desks or for bench desks with 38mm middle gap

- 1) Rail
- 2) Pair of steel fixing brackets, screw to the underside of the top (metal-to-metal)

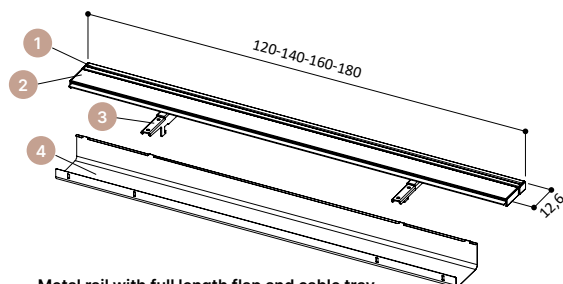
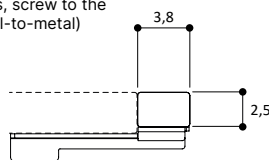

Metal rail with full length flap and cable tray for single desks

- 1) Rail
- 2) Full length cable flap
- 3) Pair of steel fixing brackets, screw to the underside of the top (metal-to-metal)
- 4) Metal cable tray

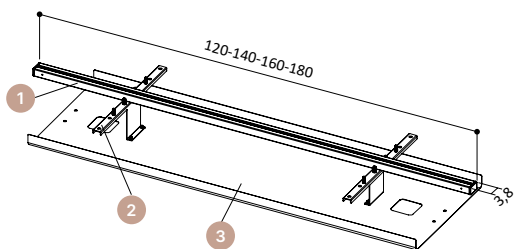
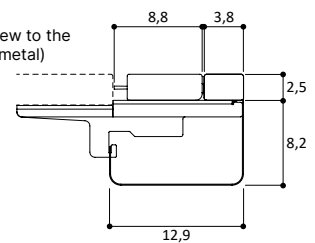

Metal rail with high capacity cable tray for bench desks with 38mm middle gap

- 1) Rail
- 2) Pair of steel fixing brackets, screw to the underside of the tops (metal-to-metal)
- 3) High capacity metal cable tray

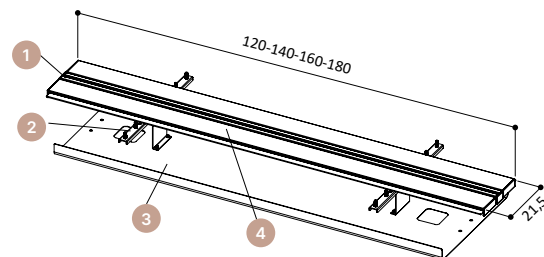
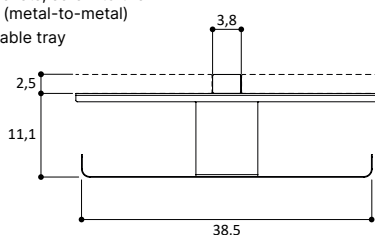

Metal rail with two full length flaps and high capacity cable tray for bench desks with 215mm middle gap

- 1) Rail
- 2) Pair of steel fixing brackets, screw to the underside of the tops (metal-to-metal)
- 3) High capacity metal cable tray
- 4) Full length cable flaps

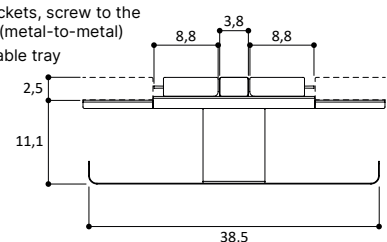

FRAMED SCREENS AND CABLE MANAGEMENT

- 1) Aluminium frame
- 2) Acoustic framed screen, surface made of fabric covered acoustic thermoformed polyester fibre
- 3) Regular framed screens feature six surface options:
 - 8mm MFC panel;
 - fabric covered honeycomb core sandwiched between MDF panels;
 - 8mm wood effect melamine faced chipboard (MFC);
 - 8mm plywood core sandwiched between acoustic polyurethane foam sheets, fabric covered;
 - translucent pinstriped polycarbonate;
 - translucent matt white acrylic.

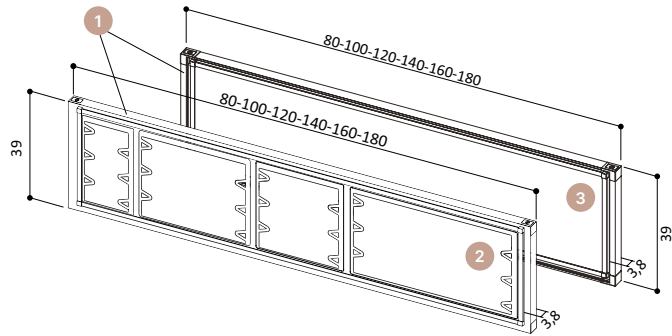

OPTIONS FOR SINGLE & BENCH DESKS (A FRAMED SCREEN IS REQUIRED IN ALL SCENARIOS)



Fixing brackets when no cable management is required

- 1) Pair of steel fixing brackets for framed screens, screw to the underside of the top (metal-to-metal fixing)

Note: framed screen required

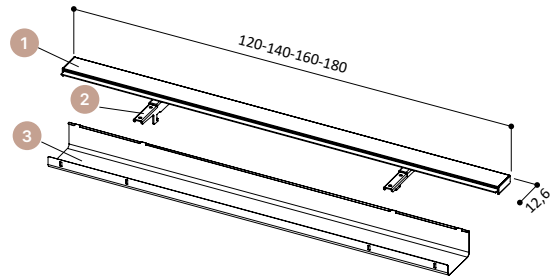

Fixing brackets with full length flap and cable tray for single desks

- 1) Full length cable flap
- 2) Pair of steel fixing brackets holding framed screen and cable tray, screw to the underside of the top (metal-to-metal fixing)
- 3) Metal cable tray

Note: framed screen required

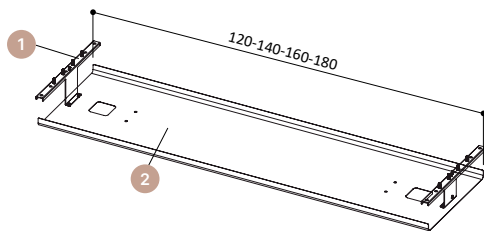
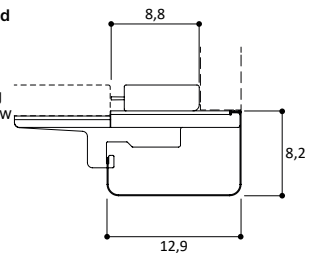

Fixing brackets with high capacity cable tray for bench desks with 38mm middle gap

- 1) Pair of steel fixing brackets holding framed screen and high capacity cable tray, screw to the underside of the top (metal-to-metal fixing)
- 2) High capacity metal cable tray

Note: framed screen required

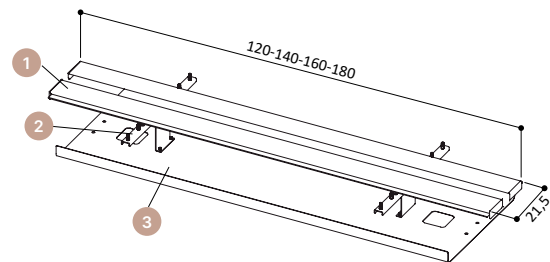
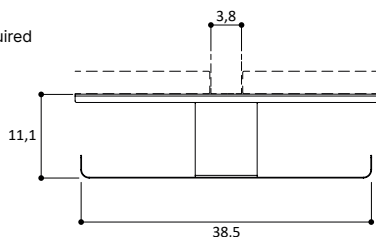

Fixing brackets with two full length flaps and high capacity cable tray for bench desks with 215mm middle gap

- 1) Full length cable flaps
- 2) Pair of steel fixing brackets holding framed screen and high capacity cable tray, screw to the underside of the top (metal-to-metal fixing)
- 3) High capacity metal cable tray

Note: framed screen required

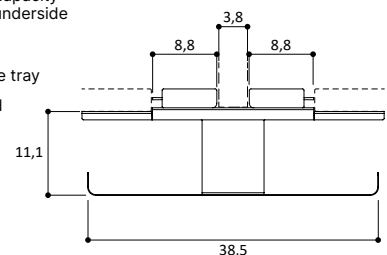



Ø60mm ABS grommet



Aluminium cable flap with open ended cable tray under



PVC cable tray (optional extra)



Silver effect steel wire basket inclusive of mounting brackets



High capacity metal cable tray for bench desks



Metal tower for vertical cable management



Translucent ABS cable spine



"Strap" CPU holder

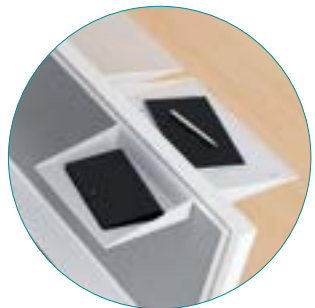



Tool bar and trays/pen pots



MATERIALS AND RECYCLABILITY

Panels used on IDEA+PANNELLO range are exclusively 100% made by recycled wood and respect low formaldehyde emission (CATAS certification Quality Award CARB). Resins used on panels and melamine paper are SVHC substances free (reported on ECHA list update to 12/01/2017)

DESK WITH METAL FRAME

	POST-CONSUMER RECYCLABLE
 Wood	100%
 Plastic	100%
 Metal	100%
 Mixed	If disposed of in a specialised facilities

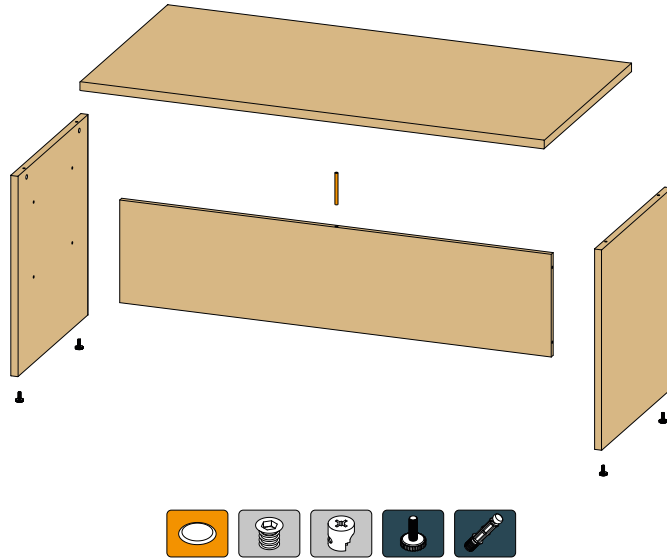



STANDARDS

The Idea+ Pannello has passed the following tests as certified by the **CNTS** Laboratories in San Giovanni al Natisone - Udine, Italy.

- Tables and desks dimensions EN 527-1:2011
- Horizontal static load test EN 1730:2012, clause 6.2
- Vertical static load test EN 1730:2012, clause 6.3
- Horizontal fatigue test EN 1730:2012, clause 6.4.2
- Vertical fatigue test EN 1730:2012, clause 6.5
- Vertical impact test EN 1730:2012, clause 6.6
- Deflection of table tops EN 1730:2012, clause 6.7
- Drop test EN 1730:2012, clause 6.9
- Stability under vertical load EN 1730:2012, clause 7.2



CERTIFICATIONS

Constantly receptive to market requirements, Quadrifoglio Sistemi d'Arredo pay special attention on quality and safety contents in order to provide high products and services. The Company has reached certifications UNI EN ISO 9001/2015, UNI EN ISO 14001/2015 and UNI EN ISO 45001/2018 to confirm his policy. Our products are certified and ensured by FSC™ and ECOLOGICAL PANEL.



GREEN ENERGY

The Company had installed the photovoltaic system with 4.500 solar panels in a 7.350 m² surface that covers almost entirely the factory. The photovoltaic is able to produce 1Mw of a quiet green energy, that does not harm the environment and is waste-free. With his high production capacity the photovoltaic allows us to reduce emissions in the atmosphere of all those polluting substances and to those that contribute to the greenhouse effects. Consequently, such measures make us save every year 180 tonne of petrol oil, 440 tonne of CO₂, 514kg of sulphur dioxide, 448 kg of nitrogen oxide and 23kg of dust.



TRANSPORT

Packaging is reduced in order to decrease volumes. Goods collections are responsibly managed and organised with the aim of optimise transports, reducing atmosphere emissions.