

RECEPTION
GLASS

design office



COUNTERTOPS

Made from 10mm fingerprint-proof back painted tempered glass with a satin white finish. Floating top supported on stainless steel spacers. 45° smooth polished edges and radiused corners.

Finish options:



FRONT AND END PANELS

End/side panels made from 18mm easy to clean scratch-resistant anti-reflective melamine faced chipboard (MFC) finished with 1 mm impact resistant matching Abs edges.

Straight front panels made from 18mm easy to clean scratch-resistant anti-reflective melamine faced chipboard (MFC) finished with 1mm impact resistant matching Abs edges.

Curved front panels made from 18mm CPL laminate faced chipboard.

End/side & front panels are supplied with adjustable levelling feet for uneven floor surfaces.

Panel density: 670/730 kgs per cubic meter.

WORKTOPS

Made from 30mm easy to clean scratch-resistant anti-reflective melamine faced chipboard (MFC) finished with 2mm impact resistant matching Abs edges. All tops are supplied with one or two ø60mm portholes complete with ABS circular grommet.

Panel density: 670/730 kgs per cubic meter.

Finish options:



Production lead time: 5 weeks excluding delivery time. Apart from the shown finish options any RAL color can be made to order.

TUBULAR LEGS, FEET AND MOUNTING BRACKETS

Tubular legs made from ø60mm epoxy powder coated steel tube, supplied with levelling feet. Mounting brackets and feet made from epoxy powder coated steel.

Finish options:

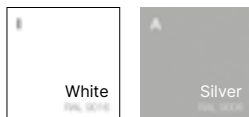

DECORATIVE STRIPES

Peel-and-stick (optional) plastic decorative stripes available in a chrome finish.

120° CONFIGURATION

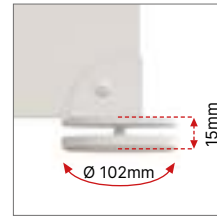
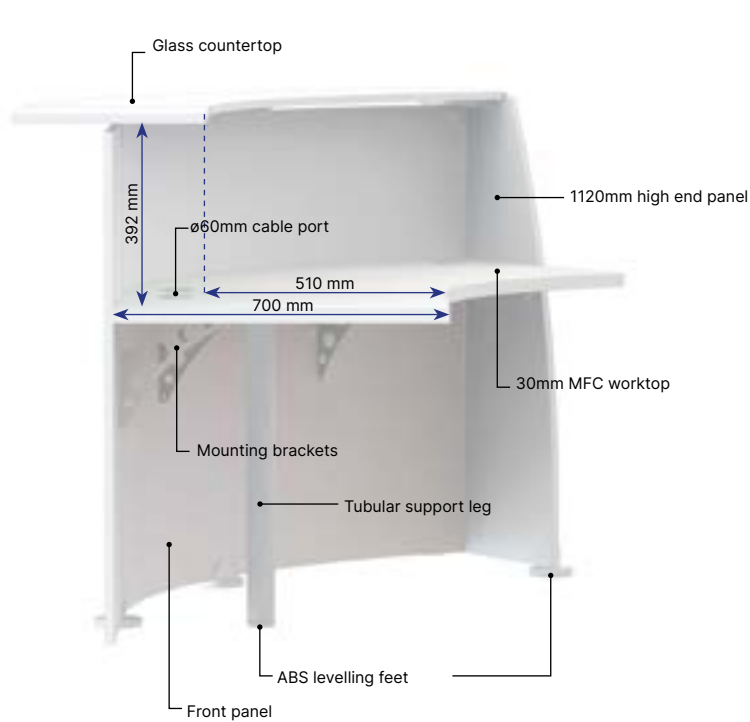

ø102mm metal foot with 0-15mm ABS leveller in a chrome finish.

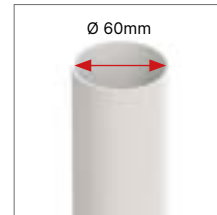

1.5mm ø60mm steel tubular leg.

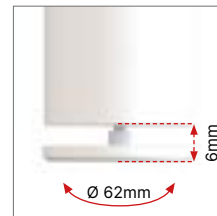

Tubular support leg: ø62mm metal foot with 0-6mm ABS leveller in a chrome finish.

CONFIGURATION INCLUDING LOW COUNTER

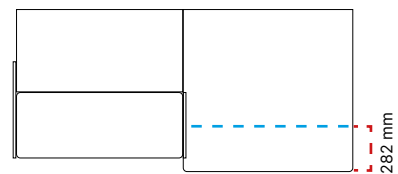
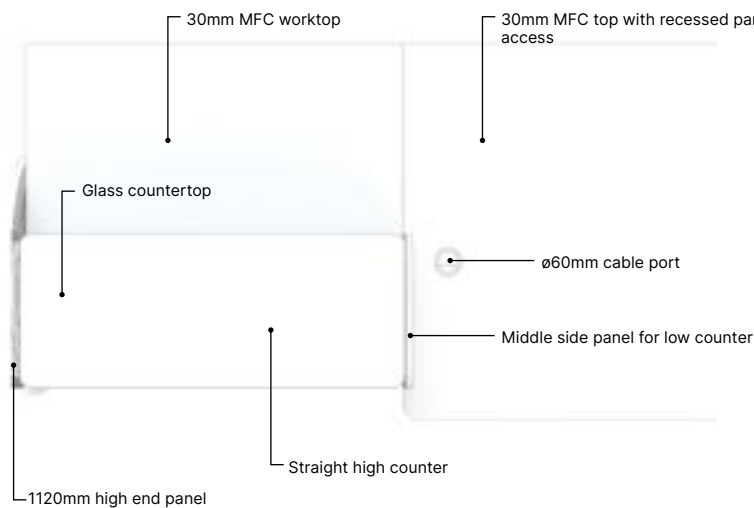

MODULES

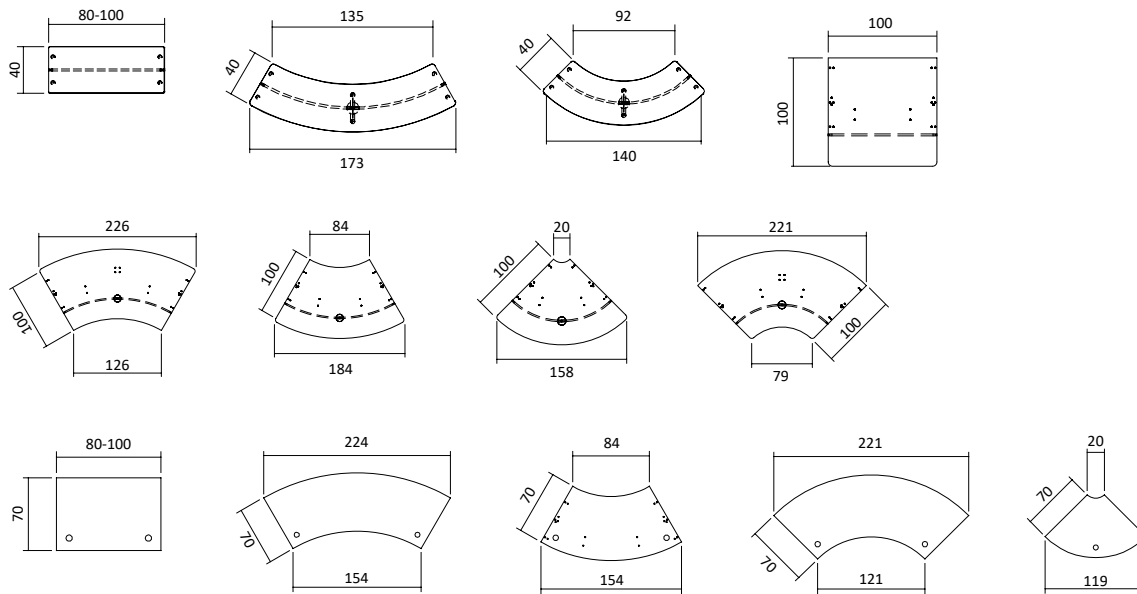

A FEW CONFIGURATIONS

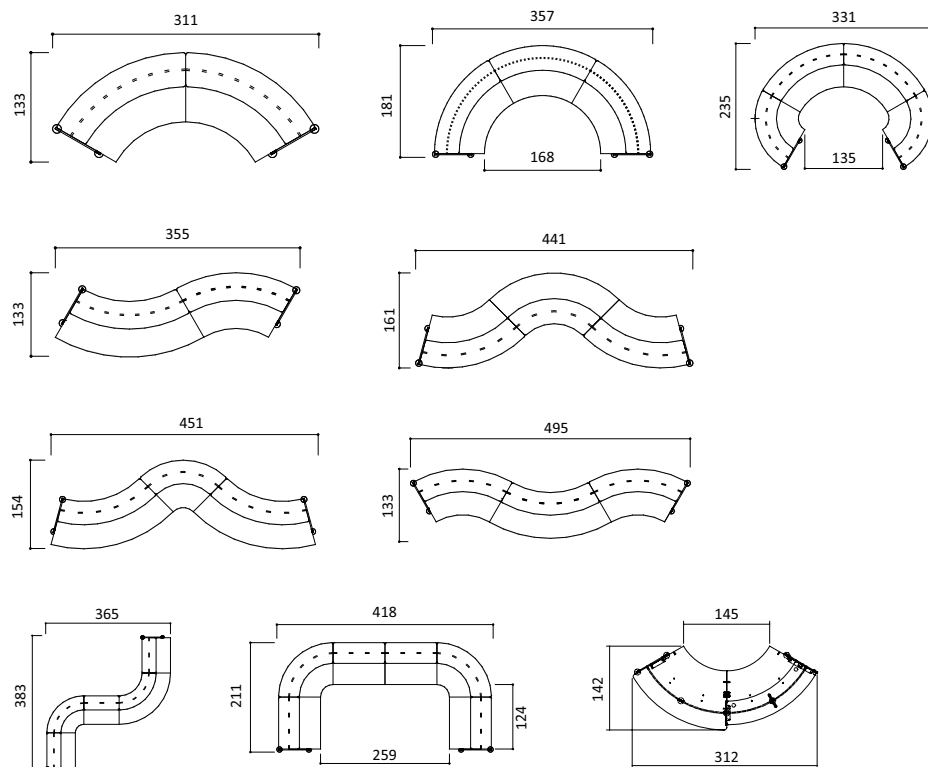

EXAMPLE 1

- 1) REBV060 60° curved high counter with glass countertop
- 2) REBV090 90° curved high counter with glass countertop
- 3) REBV100 1000mm long straight high counter with glass countertop
- 4) REFC001 Pair of end side panels
- 5) REST151 Concave worktop for 60° curved counter
- 6) REST211 Convex worktop for 60° curved counter
- 7) REST201 Convex worktop for 90° curved counter
- 8) REST091 Concave worktop for 90° curved counter
- 9) REST101 Straight worktop for straight counter
- 10) REGA001 Tubular support leg
- 11) RESU001 Linking kit between two high counters
- 12) RESU003 Pair of mounting brackets link worktop to front panel

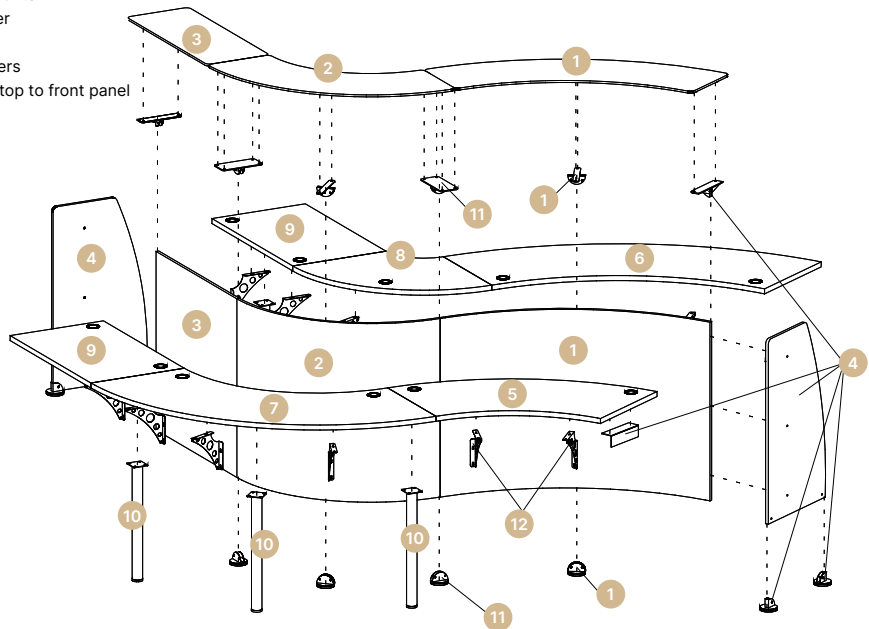

EXAMPLE 2

- 1) REBM093 90° curved low counter with MFC worktop
- 2) REBM102 Straight low counter with MFC worktop
- 3) REBV090 90° curved high counter with glass countertop
- 4) REBV100 1000mm long straight high counter with glass countertop
- 5) REST201 Convex worktop for 90° curved counter
- 6) REST101 Straight worktop for straight counter
- 7) REFC016 LH low end side panel
- 8) RESU020 Linking kit between two low counters
- 9) REFC014 Linking kit between a high counter and a low counter
- 10) REGA001 Tubular support leg
- 11) RESU001 Linking kit between two high counters
- 12) RESU003 Pair of mounting brackets link worktop to front panel
- 13) REFC012 RH high end side panel

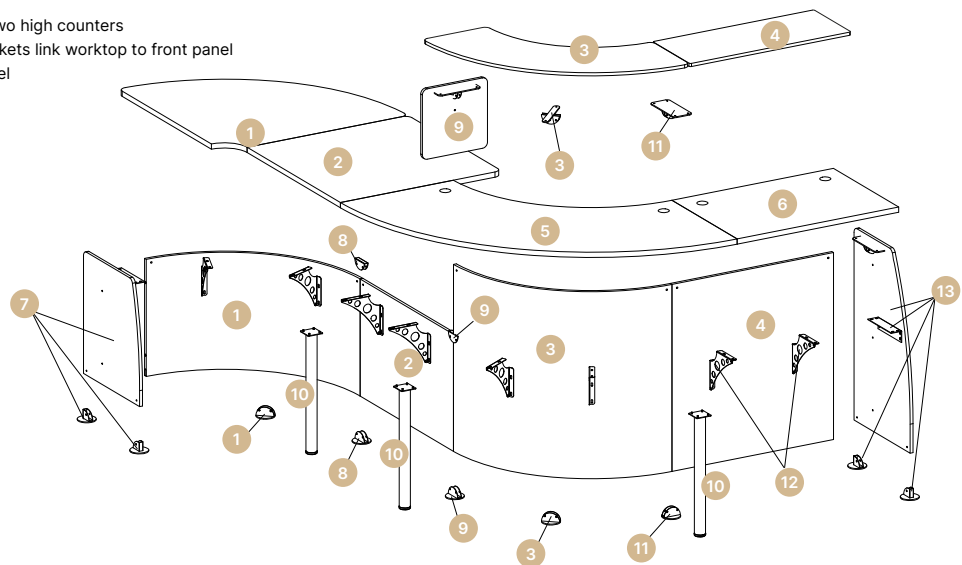



MATERIALS AND RECYCLABILITY

MFC panels used for Reception Glass range tables are solely manufactured with 100% recycled wood and fully meet requisites of formaldehyde low emissions (CARB Quality Award CATAS Certificate). Rasins used for panels and melamines are free of SVHC substances (to be found in the ECHA list updated as of 12/01/2017).



CERTIFICATES

Constantly receptive to market requirements, Quadrifoglio Sistemi d'Arredo pay special attention on quality and safety contents in order to provide high products and services. The Company has reached certifications UNI EN ISO 9001/2015, UNI EN ISO 14001/2015 and UNI EN ISO 45001/2018 to confirm his policy. Our products are certified and ensured by FSC™ and ECOLOGICAL PANEL.



GREEN ENERGY

The Company had installed the photovoltaic system with 4.500 solar panels in a 7.350 m² surface that covers almost entirely the factory. The photovoltaic is able to produce 1Mw of a quiet green energy, that does not harm the environment and is waste-free. With his high production capacity the photovoltaic allows us to reduce emissions in the atmosphere of all those polluting substances and to those that contribute to the greenhouse effects. Consequently, such measures make us save every year 180 tonne of petrol oil, 440 tonne of CO₂, 514kg of sulphur dioxide, 448 kg of nitrogen oxide and 23kg of dust.



TRANSPORT

Detachable systems. Volumes that facilitate the optimization of space. Maximum reduction of energy consumption by transport.