

# T45

design office



**DESKTOP**

38mm easy to clean scratch-resistant anti-reflective melamine faced chipboard (MFC) tops finished with 2mm matching straight Abs impact resistant edges. Tops are linked to the legs by 45° mitred joints to form 90° corners.  
 Panel density: 670/730 kgs per cubic meter

Finish options:



**PANEL END LEG**



Made from 38mm easy to clean scratch-resistant anti-reflective melamine faced chipboard (MFC) finished with 2mm matching straight Abs impact resistant edges  
 Panel density: 670/730 kgs per cubic meter

Finish options:

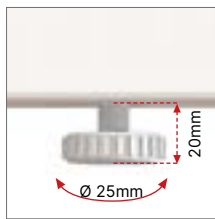
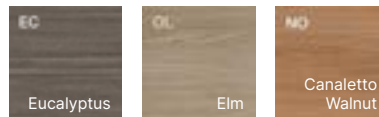

0-20mm steel adjustable levelling feet with round Abs molded scratch-resistant base. 25mm diameter.

**MODESTY PANEL**

18mm easy to clean scratch-resistant anti-reflective melamine faced chipboard (MFC) structural modesty panel finished with 1mm matching straight Abs impact resistant edges  
 Panel density: 670/730 kgs per cubic meter

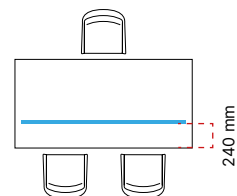

**RETURN UNIT**

Return unit sitting 38mm below desktop surface. Fabricated from 38mm easy to clean scratch-resistant anti-reflective melamine faced chipboard (MFC) finished with 1.5mm matching straight Abs impact resistant edges. Panels are linked together by 45° mitred joints to form 90° corners.

**COMBINATION UNIT SUPPORTING FLUSH RETURN TOP**

Fabricated from 18mm easy to clean scratch-resistant anti-reflective melamine faced chipboard (MFC) finished with 1.5mm matching straight Abs impact resistant edges. Panels are linked together by 45° mitred joints to form 90° corners.  
 The combination unit back can either come in 18mm melamine faced chipboard (MFC) or 1mm matt white fingerprintproof scratch resistant epoxy powder coated perforated steel sheet metal.

**SUPPORTING SLIDING DOOR LOW CREDENZA UNIT**

Fabricated from 18mm easy to clean scratch-resistant anti-reflective melamine faced chipboard (MFC) finished with 1mm matching straight Abs impact resistant edges. Four 94×30mm pentagon-shaped matt white epoxy powder coated steel legs complete with 0-20mm steel adjustable levelling feet with round Abs molded scratch-resistant base. The credenza back can either come in 18mm melamine faced chipboard (MFC) or 1.5mm thick matt white fingerprint-proof scratch resistant epoxy powder coated perforated steel sheet metal.

**RETURN UNITS: STATIC PEDESTAL**

Carcass made of 18mm melamine faced chipboard (MFC) finished with 0.4mm melamine edging. Top and drawer fronts made of 18mm melamine faced chipboard (MFC) finished with 1mm Abs impact resistant edges. Easy to clean scratch-resistant anti-reflective melamine available in four finish options with a textured and a smooth surface.

Standard metal handle  
Zen

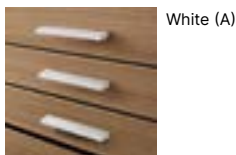

Optional metal handle  
Zen

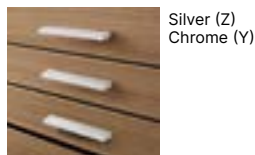

**FINISH OPTIONS**

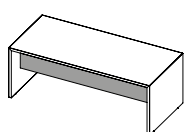

Structural modesty panel

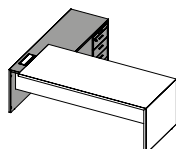

Return with static pedestal

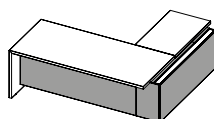

Combination unit with static pedestal

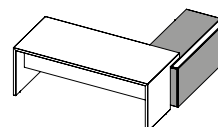

Low credenza unit

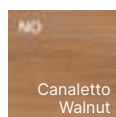
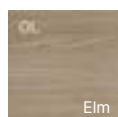
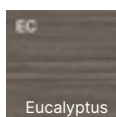

**PERFORATED METAL BACK**

Metal back fabricated from 1.5mm matt epoxy powder coated fingerprint- and scratch resistant steel sheet metal. Cable flaps above the back fabricated from epoxy powder coated 6060 extruded aluminium profiles.

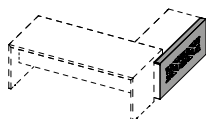

**CABLE FLAP AND CABLE TRAY**

Aluminium hinged flap with integral open ended cable tray under fabricated from zinc plated steel.

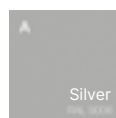
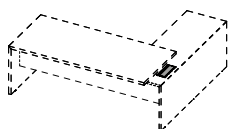

DESK

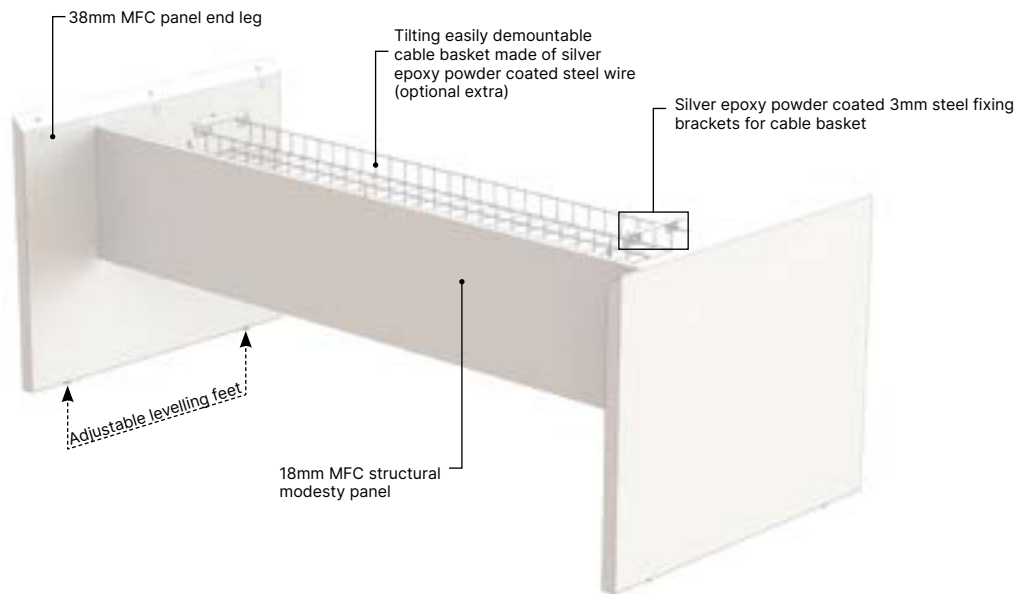

DESK WITH RETURN UNIT SITTING 38MM BELOW MAIN DESKTOP

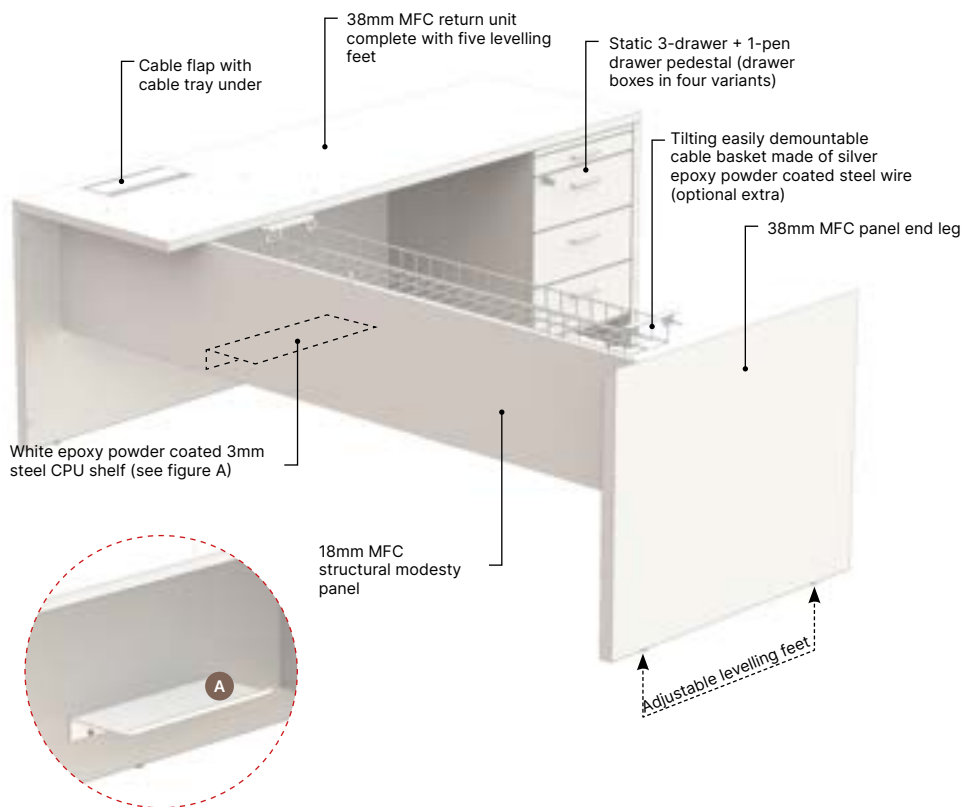

**DESK WITH LOW CREDENZA UNIT**

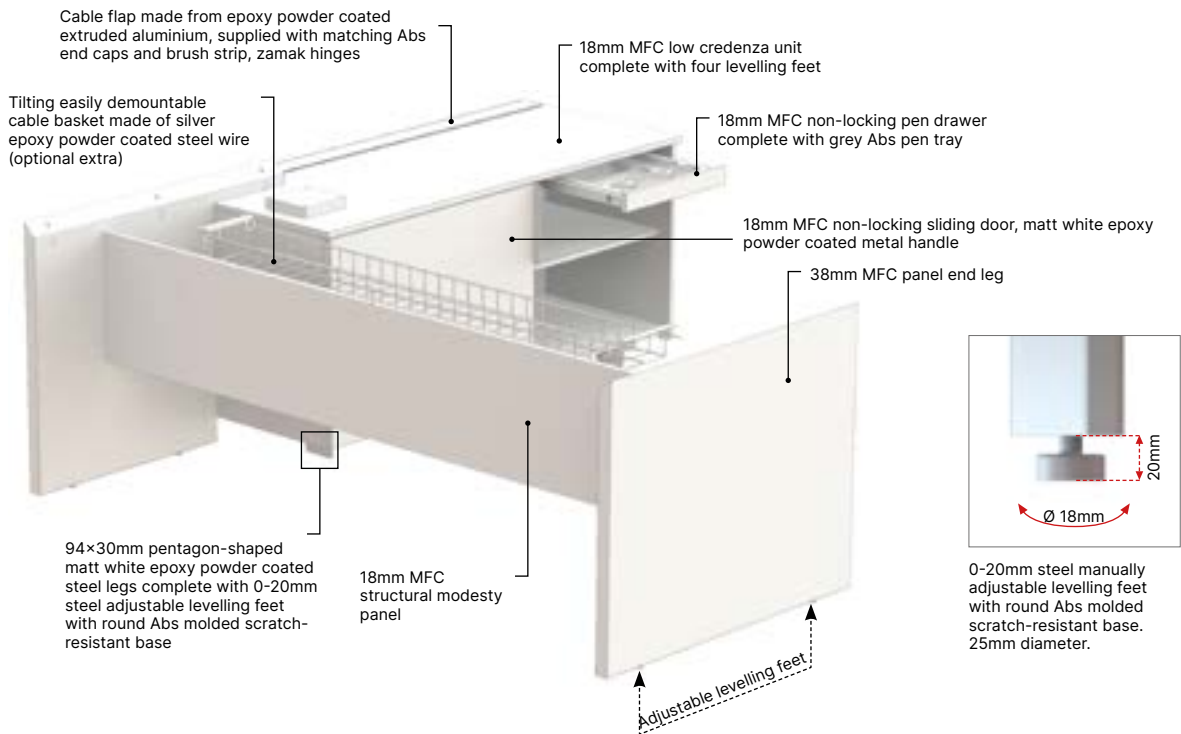

**EXPLODED VIEW LOW CREDENZA UNIT**

- 1) Hinged cable flap
- 2) 18mm MFC top
- 3) Pen Drawer
- 4) Perforated metal back also available in 18mm MFC
- 5) Ø60mm cable ports
- 6) 18mm MFC structural back
- 7) 18mm MFC side panels
- 8) 18mm MFC divider
- 9) 18mm MFC shelves
- 10) 18mm MFC bottom
- 11) Steel legs complete with levelling feet
- 12) 18mm MFC sliding door

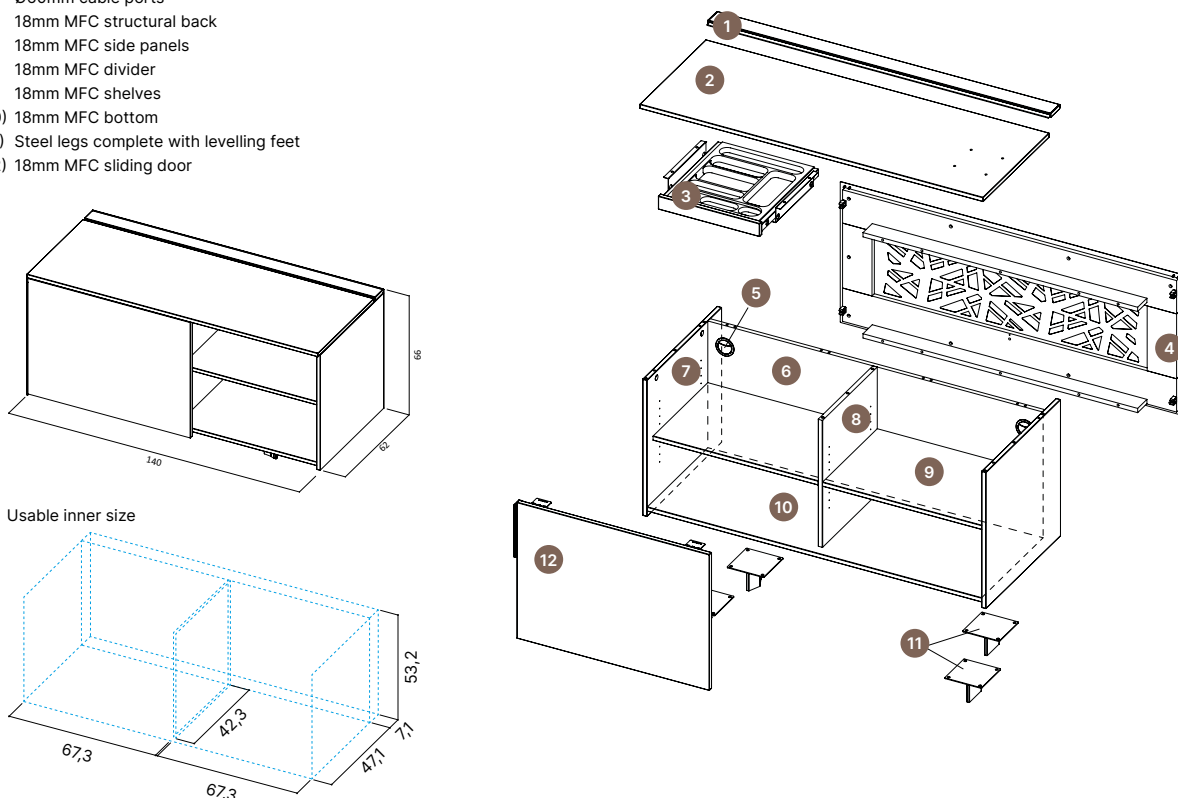

**DESK WITH FLUSH RETURN TOP AND COMBINATION UNIT**

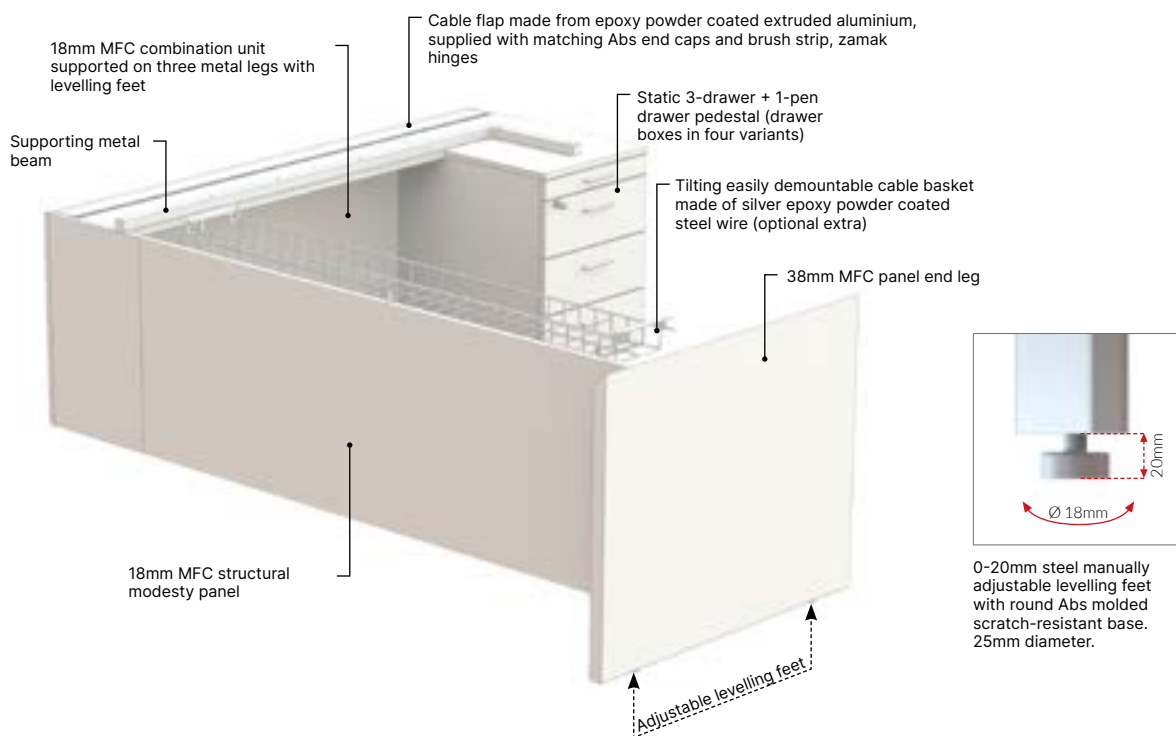

**EXPLODED VIEW COMBINATION UNIT**

- 1) Hinged cable flap
- 2) Perforated metal back also available in 18mm MFC
- 3) Static 3-drawer + 1-pen drawer pedestal (drawer boxes in four variants)
- 4) 18mm MFC top
- 5) 18mm MFC structural back
- 6) Ø60mm cable ports
- 7) 18mm MFC sides panels
- 8) 18mm MFC bottom
- 9) Ø60mm cable ports
- 10) Steel legs complete with levelling feet

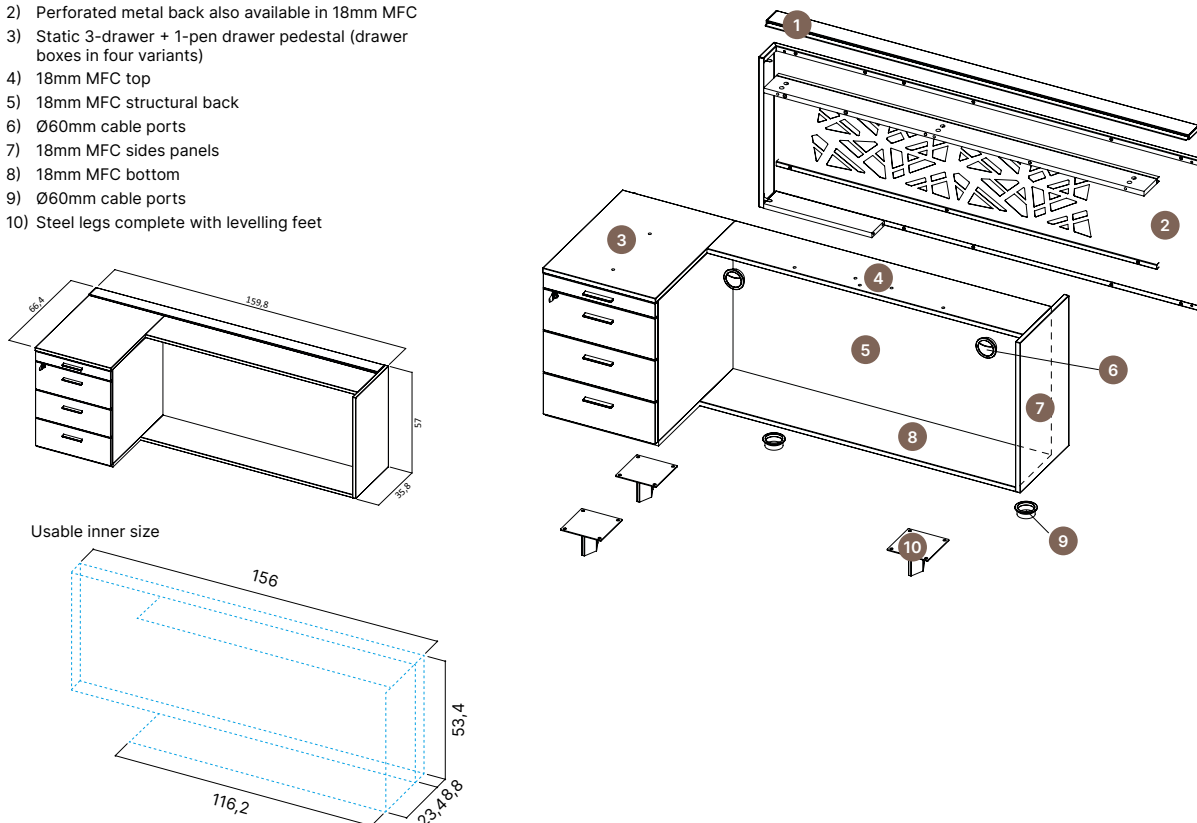

### TOPS FOR MEETING/BOARDROOM TABLES

Fabricated from 38mm easy to clean scratch-resistant anti-reflective melamine faced chipboard (MFC) finished with 2mm matching straight Abs impact resistant edges. Grain on tops runs along the length of the table (end-to-end). In cases where a table is made of two or more sections, the grain structure may vary between adjacent sections. 85mm high 30mm thick MFC built-up edges fitted to tops using 45° mitred joints to form 90° corners.

Finish options:

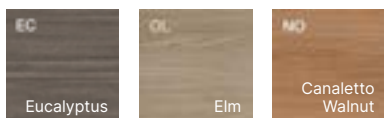

85mm high 30mm thick MFC built-up edges fitted to tops using 45° mitred joints to form 90° corners. Distance between built-up edges and floor level is approx. 645mm.

### MFC CUBED LEGS

Cubed legs made of four 30mm easy to clean scratch-resistant anti-reflective melamine faced chipboard (MFC) panels finished with 2mm matching Abs impact resistant edges. The four panels are linked together using 45° mitred joints to form 90° corners



Finish options:

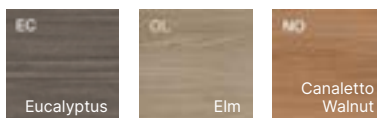

### METAL LOOP LEG FRAME

Legs made from epoxy powder coated or chromed pentagon-shaped steel tube.



Finish options:

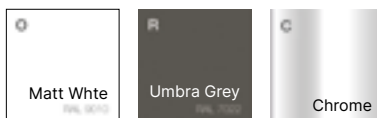

### CABLE FLAP AND CABLE TRAY

Aluminium hinged flap with integral open ended cable tray under fabricated from zinc plated steel.

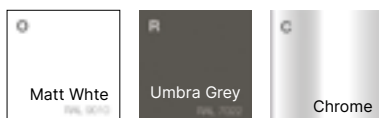
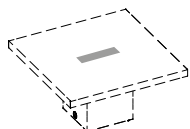

**TABLES WITH MFC CUBED LEGS**

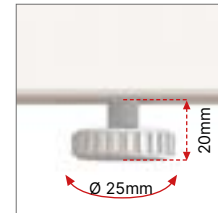
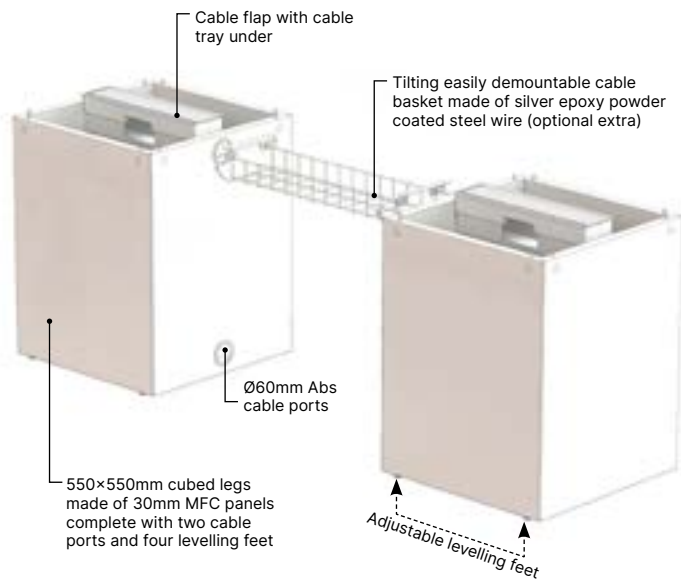

0-20mm steel manually adjustable levelling feet with round Abs molded scratch-resistant base. 25mm diameter.

**TABLES WITH METAL LOOP LEG FRAME**

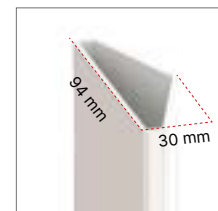
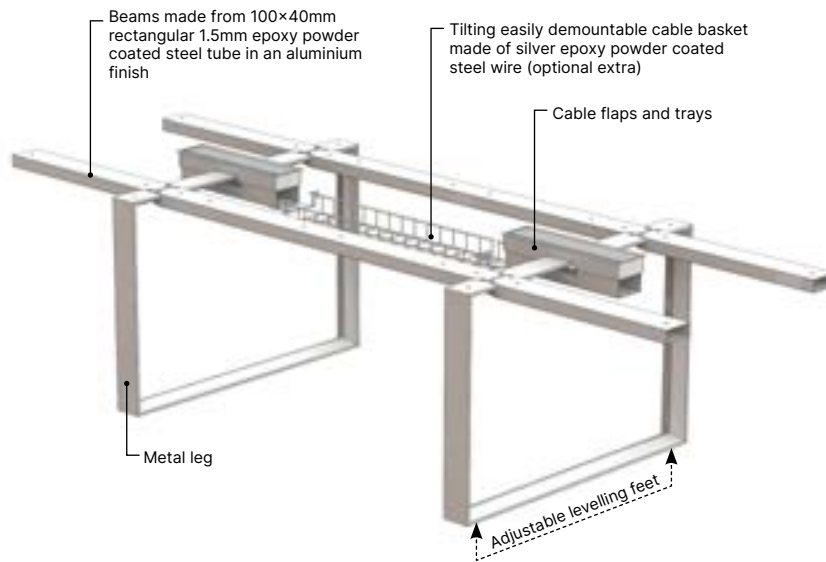

Legs made from 94x30mm pentagon-shaped 2mm steel tube.

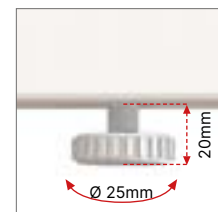

0-20mm steel manually adjustable levelling feet with round Abs molded scratch-resistant base. 25mm diameter.



**DESKS**

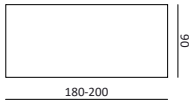

**DESKS WITH RETURN UNIT**

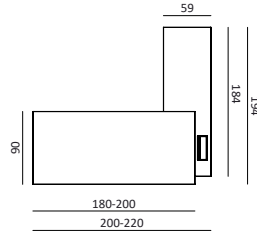
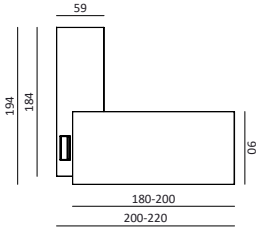

**DESKS WITH LOW CREDENZA UNIT**

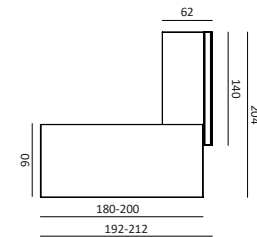
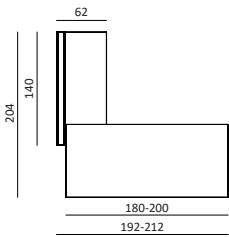

**DESKS WITH COMBINATION UNIT**

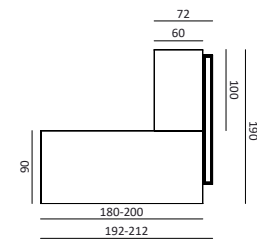
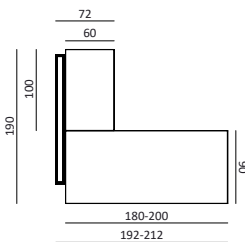

**MEETING/BOARDROOM TABLES**

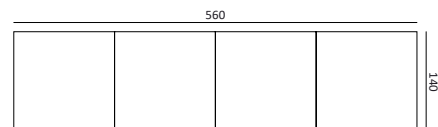
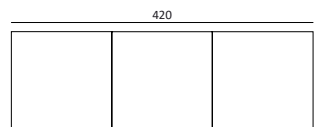
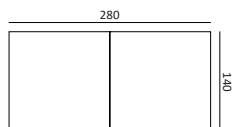
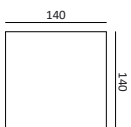

**DESKS**

**DESKS WITH RETURN UNIT**

- 1) 38mm MFC panel end leg
- 2) 38mm MFC desktop
- 3) 18mm MFC structural modesty panel
- 4) Cable basket (optional extra)
- 5) Return unit sitting below desktop
- 6) Cable flap with cable tray under
- 7) Static 3-drawer + 1-pen drawer pedestal (drawer boxes in four variants)
- 8) CPU shelf

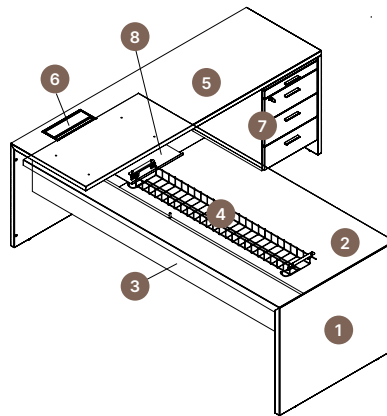

**DESKS WITH LOW CREDENZA UNIT**

- 1) 38mm MFC panel end leg
- 2) 38mm MFC desktop
- 3) 18mm MFC structural modesty panel
- 4) Cable basket (optional extra)
- 5) Sliding door low credenza unit
- 6) Perforated metal back
- 7) Melamine back

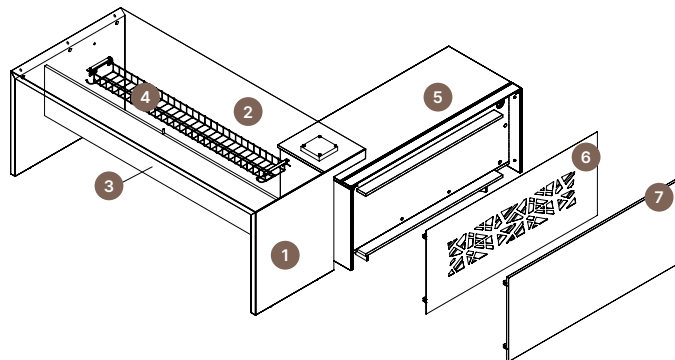

**DESK WITH COMBINATION UNIT**

- 1) 38mm MFC panel end leg
- 2) 38mm MFC desktop
- 3) 18mm MFC structural modesty panel
- 4) Cable basket (optional extra)
- 5) Combination unit
- 6) Supporting metal beam
- 7) Static 3-drawer + 1-pen drawer pedestal (drawer boxes in four variants)
- 8) Perforated metal back
- 9) Melamine back

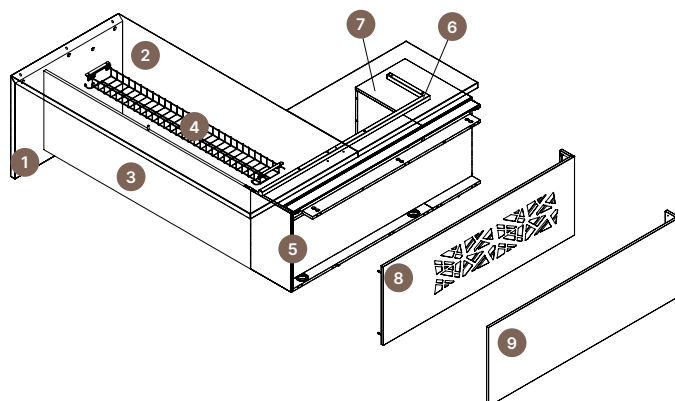



Ø60mm Abs cable port



Cable basket for desks



Abs cable spine



Cable basket for tables with loop leg frame



Cable basket for tables with cube frame







Cable flap with cable tray under



## MATERIALS AND RECYCLABILITY

Panels used on T45 range are exclusively 100% made by recycled wood and respect low formaldehyde emission (CATAS certification Quality Award CARB). Resins used on panels and melamine paper are SVHC substances free (reported on ECHA list update to 12/01/2017)

### DESK WITH METAL FRAME

	POST-CONSUMER RECYCLABLE
 Wood	100%
 Plastic	100%
 Metal	100%
 Mixed	If disposed of in a specialised facilities

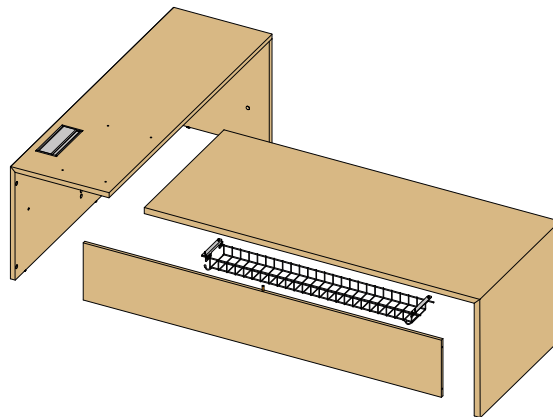

## STANDARDS

T45 range has passed the following tests, attested by **CATAS** analysis laboratory in San Giovanni al Natisone (UD).

- Office work tables: safety requirements EN 527-2:2016+A1:2019 clause 4.1 - 4.2
- Office work tables: information for use EN 527-2:2016+A1:2019, clause 6
- Tables and desks dimensions EN 527-1:2011
- Horizontal static load test EN 1730:2012, clause 6.2
- Vertical static load test EN 1730:2012, clause 6.3
- Horizontal fatigue test EN 1730:2012, clause 6.4.2
- Stiffness of the structure EN 1730:2012, clause 6.4.3
- Vertical fatigue test EN 1730:2012, clause 6.5
- Vertical impact test EN 1730:2012, clause 6.6
- Deflection of table tops EN 1730:2012, clause 6.7
- Drop test EN 1730:2012, clause 6.9
- Stability under vertical load EN 1730:2012, clause 7.2



### CERTIFICATES

Constantly receptive to market requirements, Quadrifoglio Sistemi d'Arredo pay special attention on quality and safety contents in order to provide high products and services. The Company has reached certifications UNI EN ISO 9001/2015, UNI EN ISO 14001/2015 and UNI EN ISO 45001/2018 to confirm his policy. Our products are certified and ensured by FSC™ and ECOLOGICAL PANEL.



### GREEN ENERGY

The Company had installed the photovoltaic system with 4.500 solar panels in a 7.350 m<sup>2</sup> surface that covers almost entirely the factory. The photovoltaic is able to produce 1Mw of a quiet green energy, that does not harm the environment and is waste-free. With his high production capacity the photovoltaic allows us to reduce emissions in the atmosphere of all those polluting substances and to those that contribute to the greenhouse effects. Consequently, such measures make us save every year 180 tonne of petrol oil, 440 tonne of CO<sub>2</sub>, 514kg of sulphur dioxide, 448 kg of nitrogen oxide and 23kg of dust.



### TRANSPORT

Packaging is reduced in order to decrease volumes. Goods collections are responsibly managed and organised with the aim of optimise transports, reducing atmosphere emissions.