

Atelier hanging shelf
1569 x 150 x 80 mm

1. Suspension marking

8 KG
MAX
WEIGHT

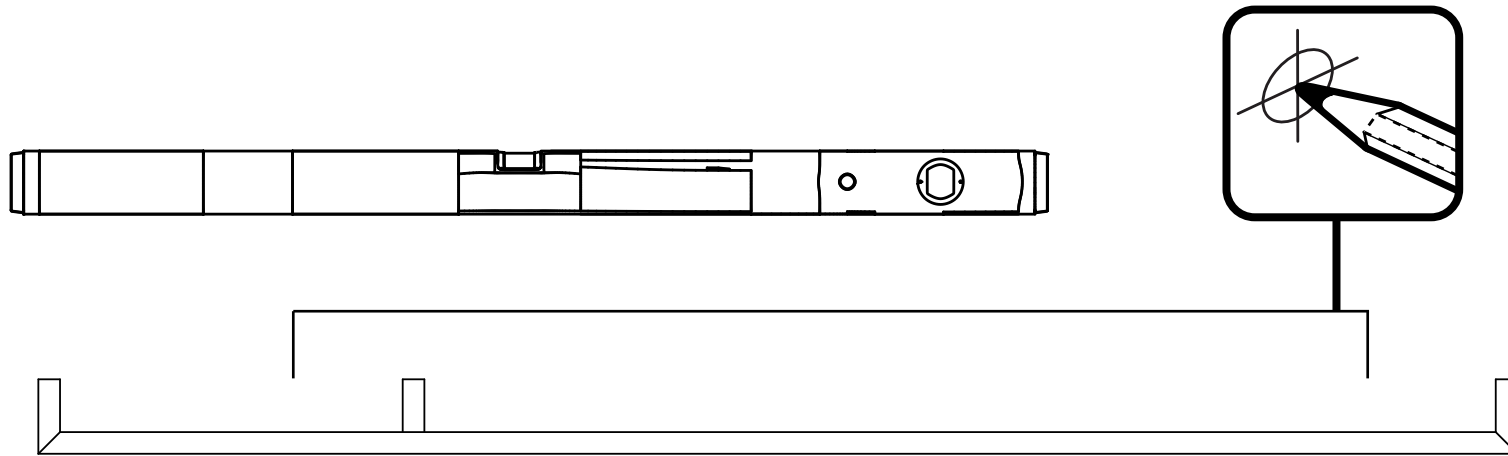

2.



- Use drill - Ø8
- Use large screws with pan head
- Use correct rawlplugs

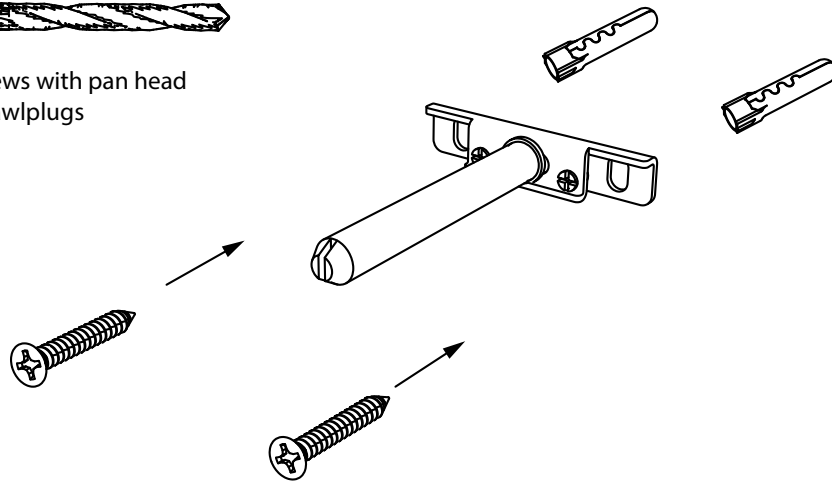

Tighten the screws

